

CAPITAL G A S

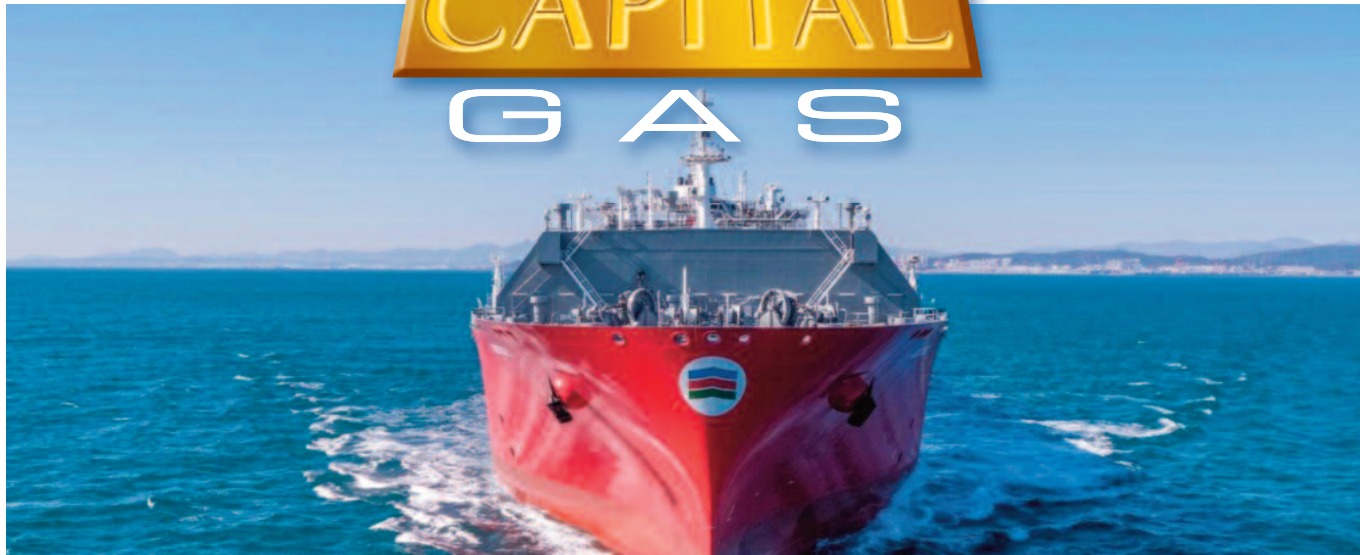

AMORE MIO I AXIOS II TBN TBN TBN

BUILT: 2023-2024

BUILDER: Hyundai Heavy Industries, S.Korea

CLASS: ABS

FLAG: MARSHAL ISLANDS



TYPE OF VESSEL SIZE CONTAINMENT SYSTEM

LNG CARRIER
174,000 m³
GTT MKIII FLEX

MAIN DIMENSIONS

Length overall abt 299 m
Length between perp. 291 m
Breadth 46,4 m
Depth 26,5 m
Draught Design (Td) 11,5 m
Draught Scantling (Ts) 12,5 m
BOR 0.085%/day ACTIVE BOR 0.040%/day

MAIN ENGINE

TYPE 2 x HYUNDAI-MAN MEGA 5G70ME-C10.5-GA-EGRBP
Nominal rating 2 x 14,150 kW, MCR: 2 x 12,112 kW

SERVICE SPEED

Service speed at Td / NCR 19.5 kts

ENERGY SAVING DEVICE

Hi-Als Air Lubrication System, Shaft Generators, Hi-Fin,
Hi-Rudder

ALL DETAILS APPROX.

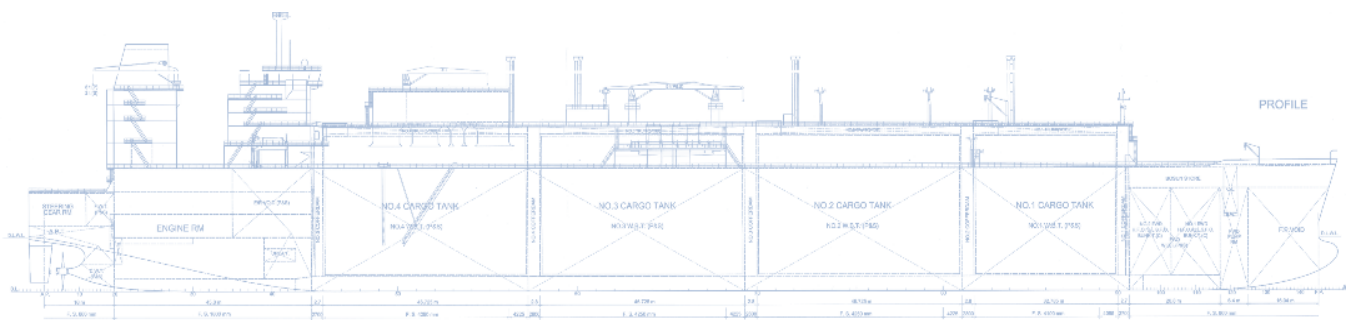

CAPITAL GAS

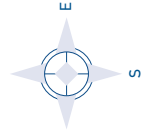
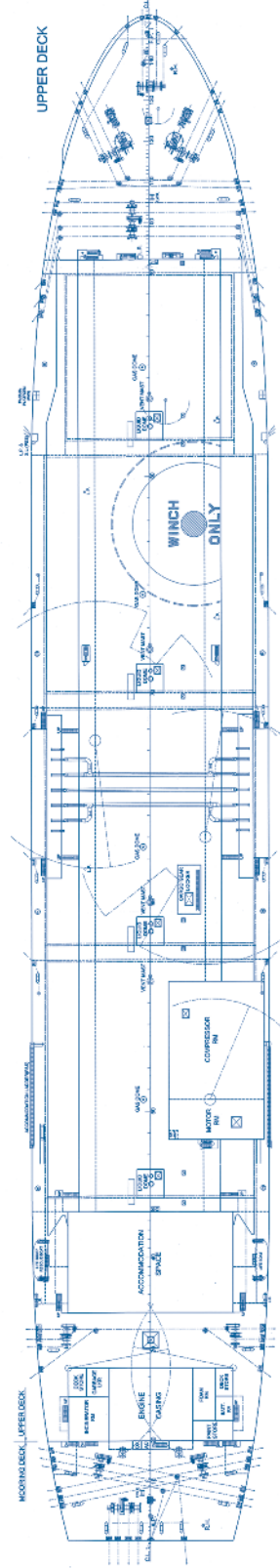
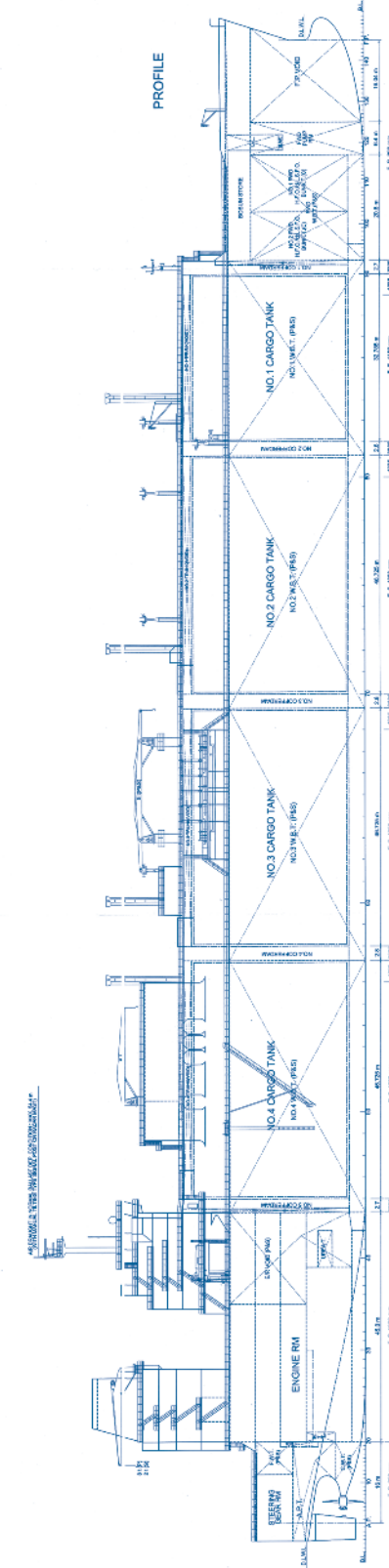
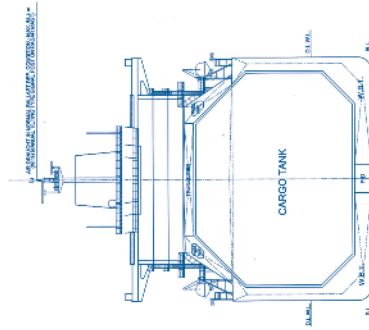
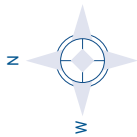

AMORE MIO I AXIOS II TBN TBN TBN

3, Iasonos Street, 18537 Piraeus, Greece
 Tel: +30 210 4584950, Fax: +30 210 4284285
 email: projects@capitalgas.gr - www.capitalgas.gr