

CAPITAL GAS

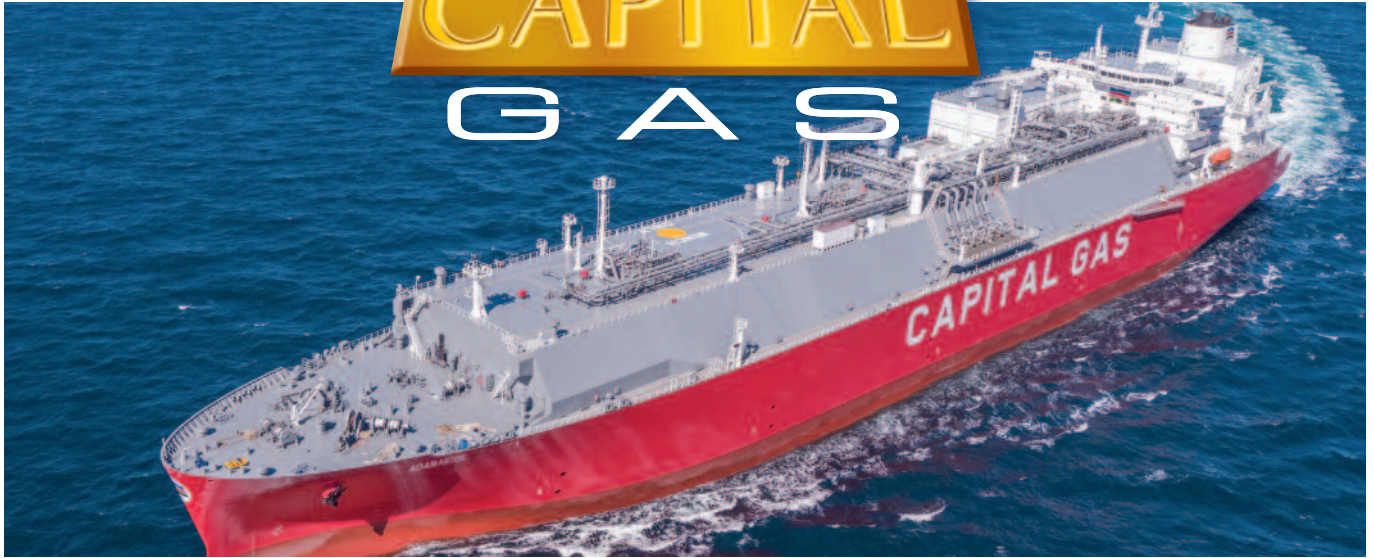

ARISTOS I ARISTIDIS I ARISTARCHOS ATTALOS ADAMASTOS ASKLIPIOS ASTERIX I

BUILT: 2020-2023

CLASS: BV/LRS/ABS

FLAG: MALTA / MARSHAL ISLANDS



BUILDER: Hyundai Heavy Industries, S.Korea

TYPE OF VESSEL

LNG CARRIER

SIZE

174,000 m³

CONTAINMENT SYSTEM

GTT MKIII FLEX

MAIN DIMENSIONS

Length overall abt

299 m

Length between perp.

291 m

Breadth

46,4 m

Depth

26,5 m

Draught Design

(Td) 11,5 m

Draught Scantling (Ts)

12,5 m

BOR

0.085%/day ACTIVE BOR 0.040%/day

MAIN ENGINE

TYPE

Two, HYUNDAI - WINGD 5X72DF

Nominal rating

WINGD 5X72DF: 2 x 16,125 Kw, MCR 2 x 12,112 kW

SERVICE SPEED

Service speed at Td / NCR

19.5 kts

ENERGY SAVING DEVICE

Hi-Als Air Lubrication System, Hi-Fin, Hi-Rudder

ALL DETAILS APPROX.

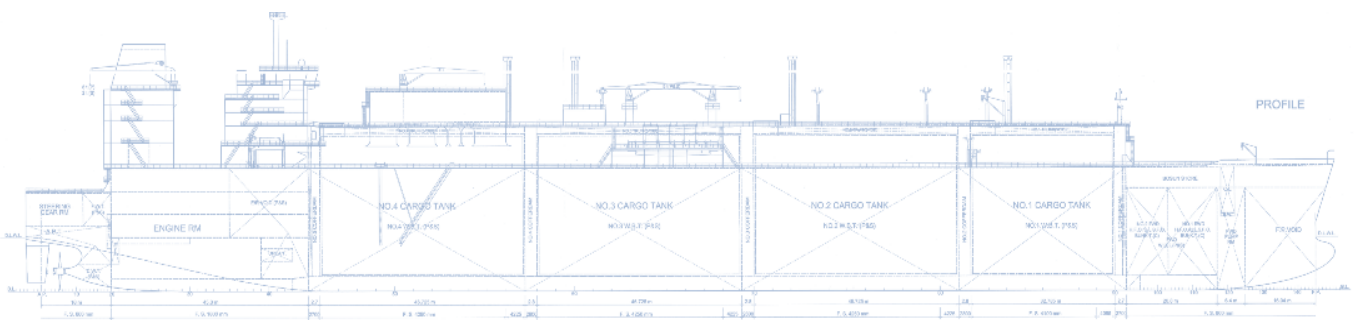

CAPITAL GAS

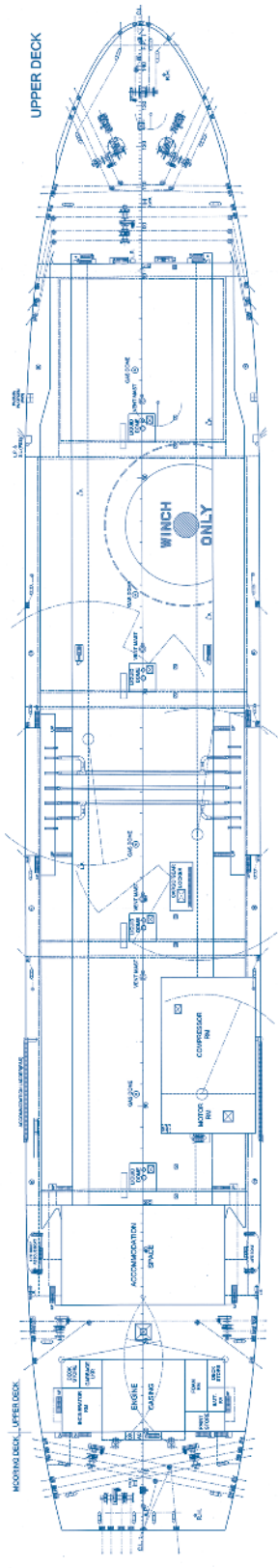
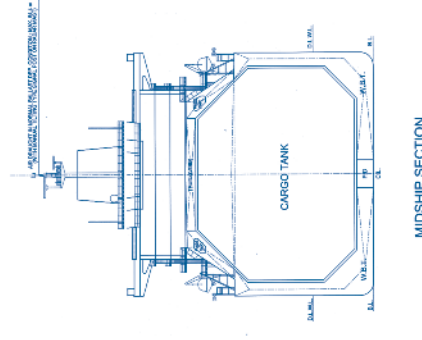
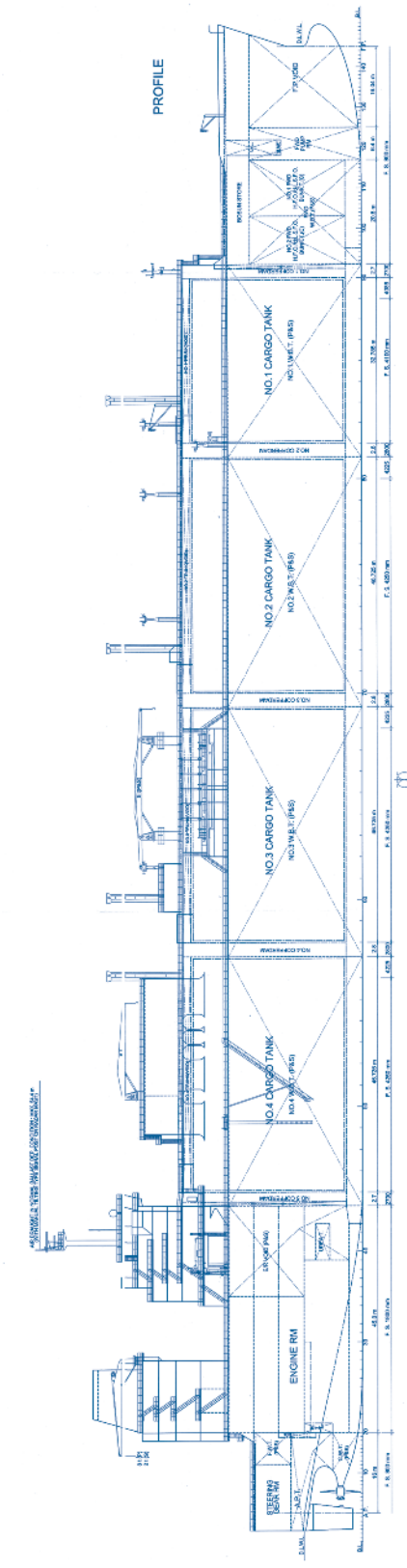
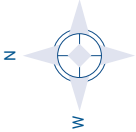

ARISTOS I ARISTIDIS I ARISTARCHOS ATTALOS ADAMASTOS ASKLIPIOS ASTERIX I

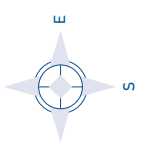

3, Iasonos Street, 18537 Piraeus, Greece
Tel: +30 210 4584950, Fax: +30 210 4284285
email: projects@capitalgas.gr - www.capitalgas.gr